

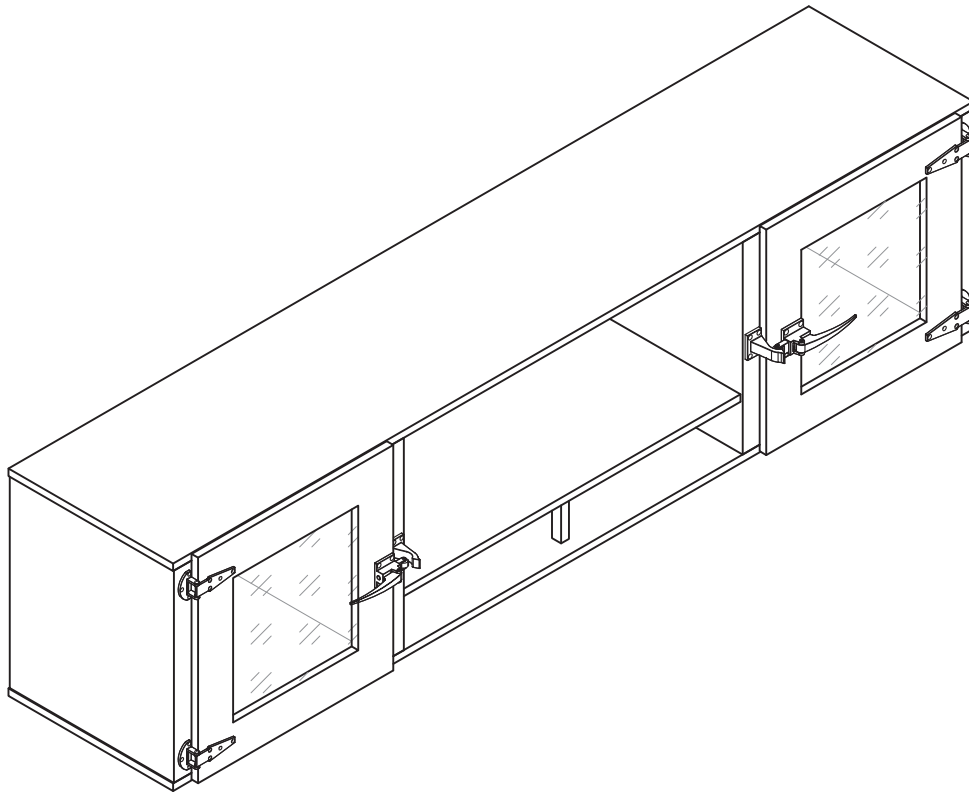









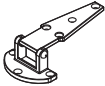

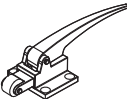

Mirella Series  
Hutch Hinged Glass Doors  
Model No. MRHTGD72 & MRHTGD66



For questions or concerns, please call 1-888-971-6225 available  
Monday-Friday 7:30 AM to 5:00 PM (Central Time)  
(English-speaking operators)

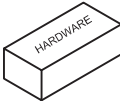

# PARTS LIST

Name	Part	Qty.	Spare Qty	Name	Part	Qty.	Spare Qty
A	 HB Hinge	4		H	 HB M8*25mm	6	
B	 HB Handle	2		I	 HB M3.5*30mm	7	1
C	 HB Handle Base	2		J	 HB M4*14mm	44	2
D	 HB 60*20*73mm	1		K	 HB M6*12mm	2	1
E	 HB Cam Post	32	1	L	 HB M6*25mm	1	
F	 HB Wood Dowel	32	1	M	 HB Cam Sticker	32	2
G	 HB Cam Lock	32	1		 HB MRHTGD66-72HB		

Items with HB are in hardware box.

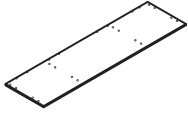
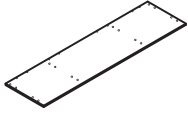
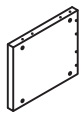
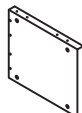
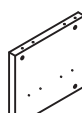
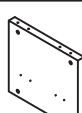
# PARTS LIST

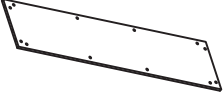
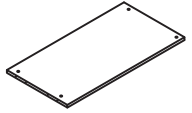
Name	Part	Qty.
N	 Top Panel	1
O	 Bottom Panel	1
P	 Left Side Panel	1
Q	 Right Side Panel	1
R	 Left Center Panel	1
S	 Right Center Panel	1

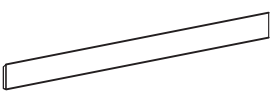
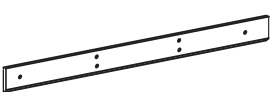
Name	Part	Qty.
T	 Back Panel	1
U	 Fixed Shelf	1
V	 Glass Door	2
W	 Wall Mounting Board	1
X	 Back cabinet Mounting Board	1

## IMPORTANT!

**Review ALL instructions before beginning assembly.** These instructions are provided to avoid problems that may occur from improper assembly or installation. SAFCO and/or its distributor are not responsible for failure resulting from improper assembly or installation of this product. Moreover, all warranties are void for failure to follow these assembly instructions.

- 1** Insert Wood Dowel (F) to Panel (T) & Insert Cam Post (E) to (Q&P). Install Cam Lock (G) to Panel (Q&P&T). Fasten Side Panel (Q&P) to Back Panel (T). If mounting on a wall, Install Mounting Board (X) to the Back Panel (T).

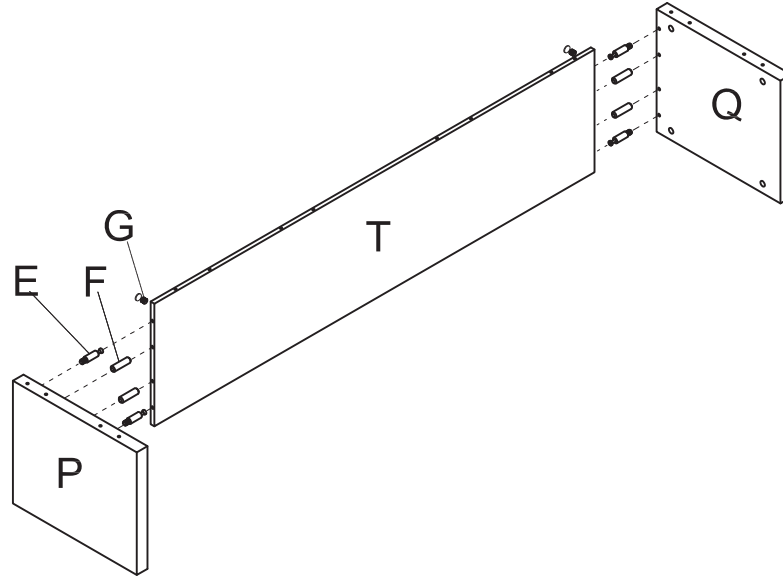

- 2** Insert Wood Dowel (F) to Panel (U) & Insert Cam Post (E) to the panels (R&S&U), Install Cam Lock (G) to Panels (R&S&U), Fasten Left / Right Side Panel (R&S) to Fixed Shelf (U). Use Screw (K) to install Support Connection(D) to Fixed Shelf (U), Attach the Cam Sticker (M) to cams;

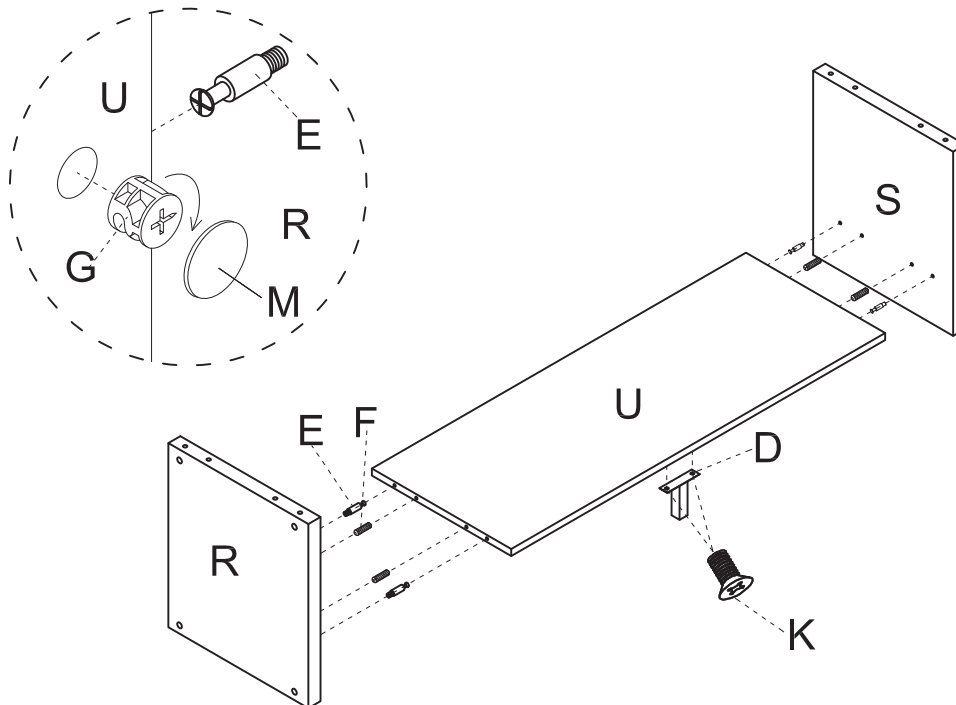

- 3** Use Wood Dowel (F), Cam Post(E) & Cam Lock (G) to fasten Top Panel (N) and Bottom Panel (O) and other panels (Q&P&R&S&T&U) together. Use Screw (L) to install Support Connection (D) to the Bottom Panel (O), Attach the Cam Sticker (M) to cams;

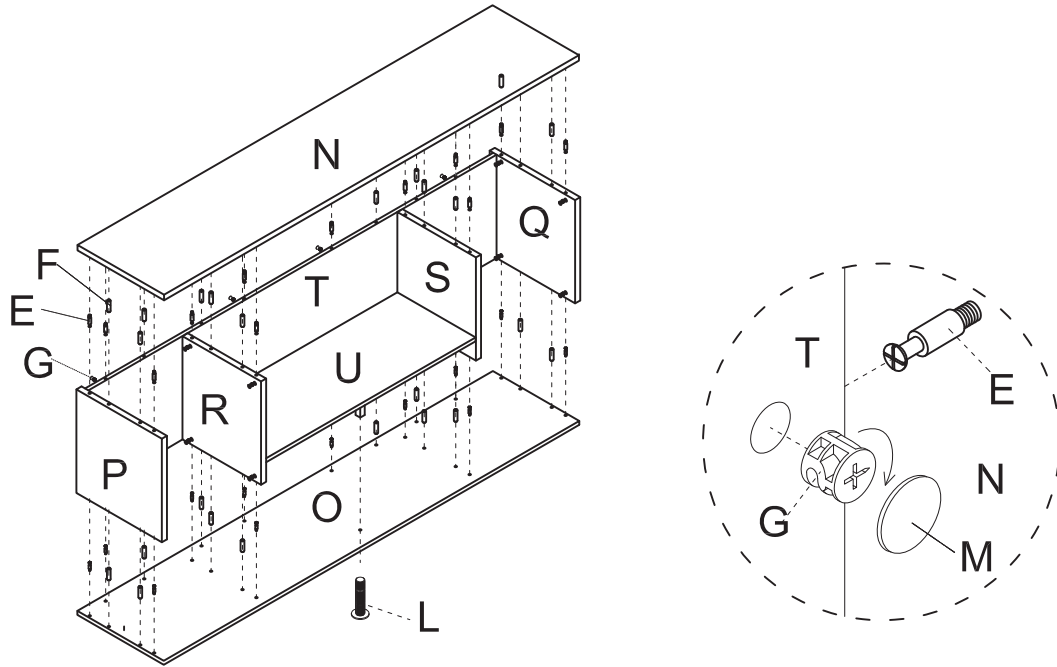

- 4** Use Screw (I) to fasten Panels (R&S&U) to Back Panel (T);

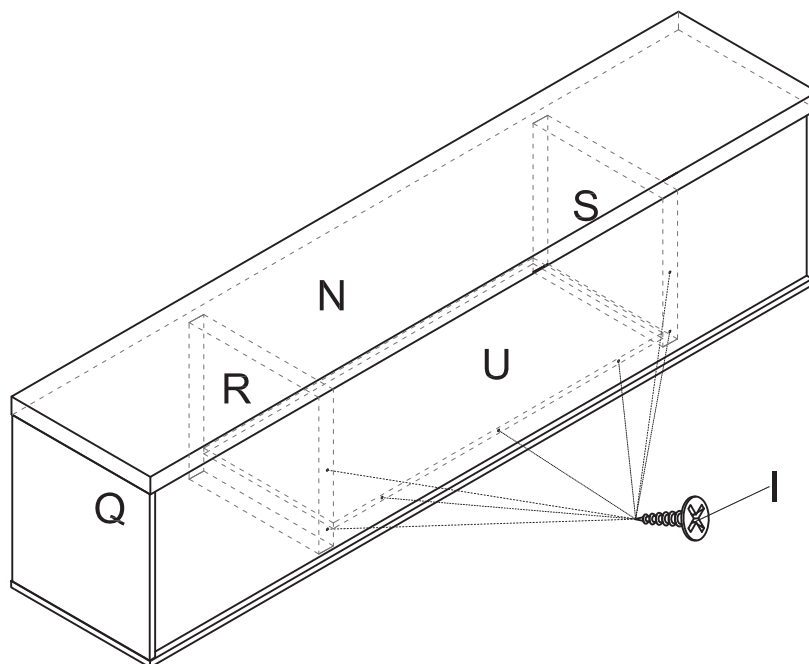

- 5** Use Screw (J) to install Handle Base (C) to the front of Left / Right Center Panel (R&S);

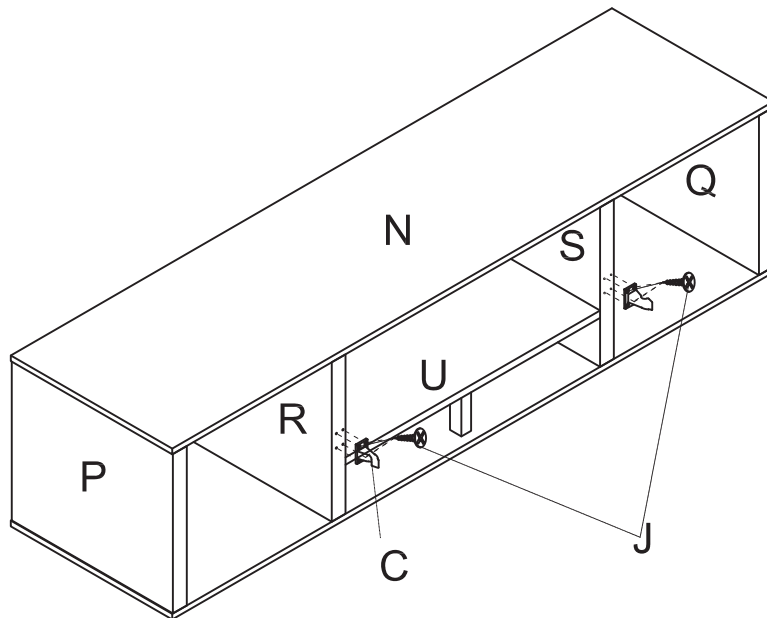

- 6** Use Screw (J) to connect the Hinge (A) and Handle (B) to the Glass Door (V);

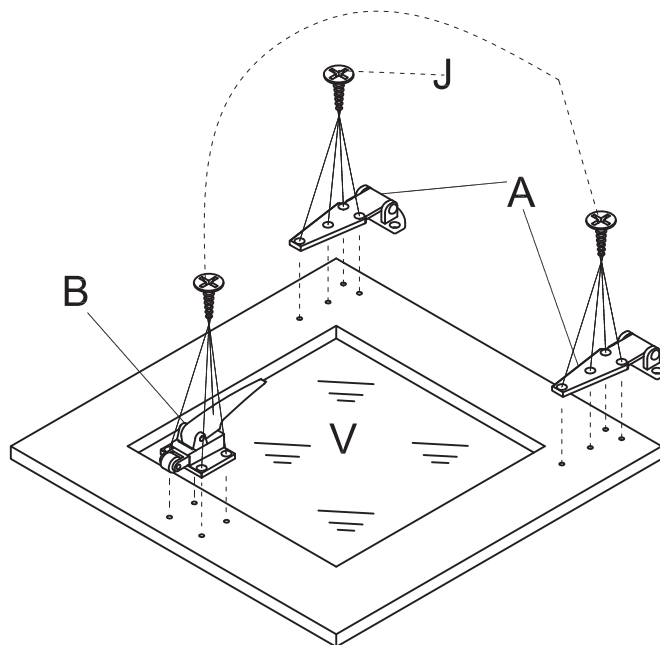

- 7** Use Screw (J) to install the Glass Doors (V) to the Left / Right Side Panel (P&Q);

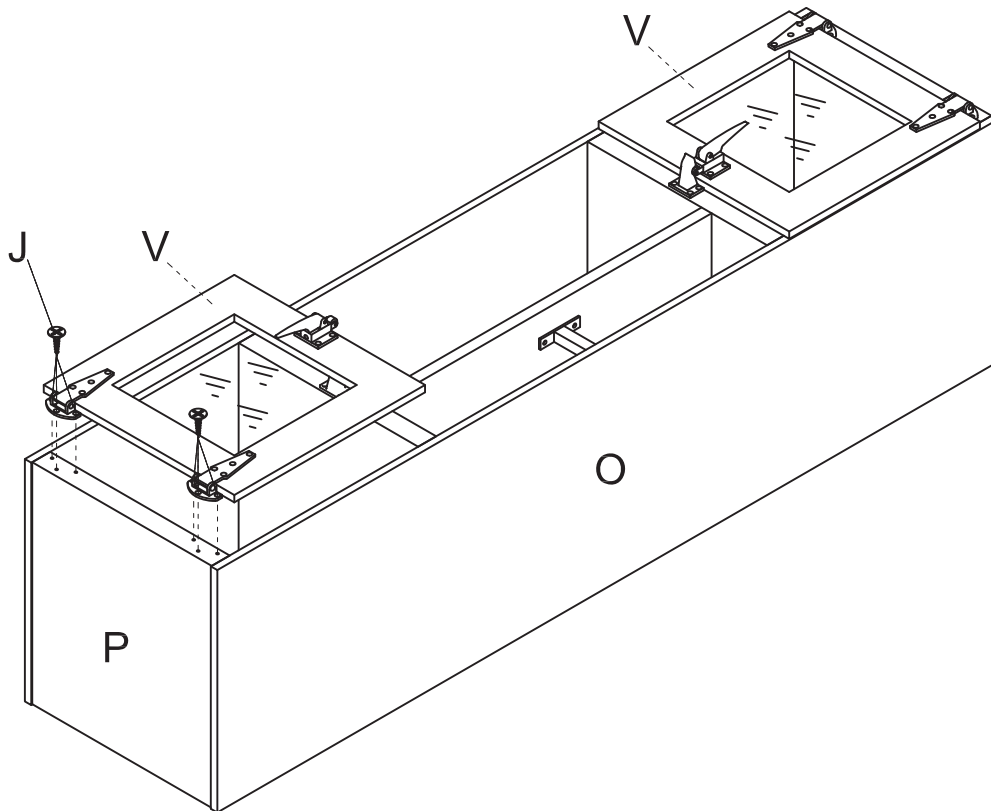

- 8 If you want to install the cabinet on the wall, please refer this instruction ;

Mounting Cabinet Installation - Due to the various wall construction methods, it is up to a professional installer to secure the Wall Mounting Board (W) to the wall with the proper fasteners and/or anchors as required by the wall construction at the desired mounting location. SAFCO does not take responsibility for safe, proper fastening.

To Hang Cabinet - Position cabinet so that Mounting Board (X) is above Wall Mounting Board (W), and lower cabinet until Mounting Board (X) and Wall Mounting Board (W) lock together.

